

F50S.110 (F50S.120) KEY TUBE LOCK CYLINDER

General

The patented, award winning iLOQ S50 locking system offers advanced security and convenient access sharing capabilities for master-key locking environments.

The iLOQ F50S key safe lock cylinder enables usage of the iLOQ S50 locking system in key safe applications where typically a third-party organization, like fire service or a telecommunication company, needs to have access to the premises/buildings using their own key. The key to the premises is placed in wall mounted key safe tubes, which the organizations can open using their mobile phones as a key.

The lock harvests electricity wirelessly from NFC field, which enables using phone not only as a key but also as a power source thus the lock is completely battery free. As no batteries and no electric wiring are required, the locks are maintenance free and environmentally friendly green solution that eliminates work, costs, waste and harm associated with battery powered or cabled solutions.

The lock doesn't have a keyway due to the contactless NFC operation. It is designed to be used in harsh environments where the locks are exposed to dust, moisture and varying temperature conditions ranging from extremely cold to hot weather.

The phone as a key enables flexible access sharing with time restrictions and audit trail reporting over the air. The security level is kept high and security gaps caused by lost key can be eliminated completely without costly change of locks and keys. The lock fits into standard 40 mm key safe tubes.

F50S key safe lock cylinder in brief

- Battery-free programmable electromechanical key tube lock cylinder for iLOQ S50 locking system
- Compatible with standard 40 mm Finnish key safe tubes
- Two different reader knob lengths available
- NFC-powered: no batteries or external power source required for the lock
- Opening with NFC enabled Android-smartphone or iLOQ K50S Key Fob
- Secured using powerful AES256 encryption and mutual authentication
- Compatible with European EN15684 standard
- FK class 3 certification pending
- Initial programming with PC and iLOQ P50S.1 admin fob in connection to server
- Access right list for access groups
- Blacklist for individual lost keys
- Internal audit trail record with time stamp (can be configured on/off)
- Supports time restrictions
- Can be configured to require online opening authentication
- Re-programming with keys (Android phone or K50S Key Fob)
- Firmware updateable

Product versions

F50S.110

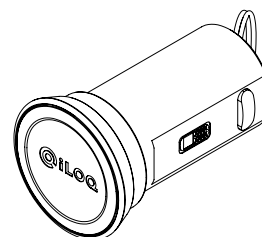
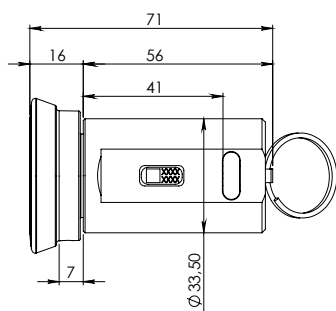

F50S.120

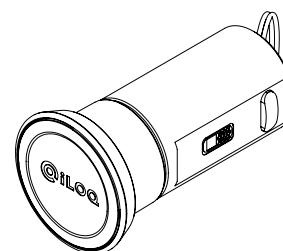
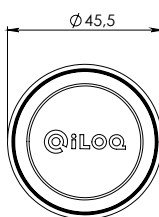
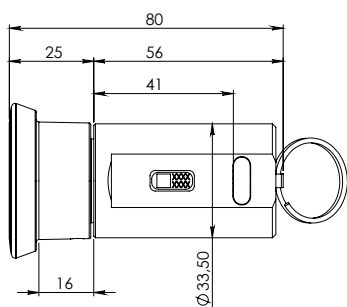

F50S.110	Key tube lock cylinder with short reader knob
F50S.120	Key tube lock cylinder with long reader knob

Memory capacity

Number of access rights	210
Number of blacklisted keys	2000
Number of time profiles	10
Event log	At least 500 with time stamp

Technical data (designed to meet following requirements, testing ongoing)

Cylinder body	Hardened + Zn electrogalvanized steel
Reader knob	Black plastic
Category of use: EN15684 (Grades 0-1)	Grade 1
Durability: EN15684 (Grades 4-6)	Grade 6, 100 000 cycles
Environmental resistance: EN15684 (Grades 0-4)	Grade 4
Electronic key related security: EN15684 (Grades A-F)	Grade F
System management: EN15684 (Grades 0-3)	Grade 3
Attack resistance: EN15684 (Grades 0-2)	Grade 2
Temperature range	-40°C to +80°C
Ingress protection rating	IP54
Certificates	FK Class 3(*)
.....	EN15684

*) F50S.110.HZ and F50S.120.HZ are approved in class 3 by the Finnish non-life insurers' Federation (FK) (Pending).