

H50S.341.110.HC Padlock with 8/110mm shackle

System-level description

The patented, award winning iLOQ S50 locking system offers advanced security and convenient access sharing capabilities for master-key locking environments.

The iLOQ H50S padlocks enable usage of the iLOQ S50 locking system for securing remote objects and locations. The lock harvests electricity wirelessly from NFC field, which enables using phone not only as a key but also as a power source thus the lock is completely battery free. As no batteries are required, the locks are maintenance free and environmentally friendly green solution that eliminates work, costs, waste and harm associated with battery powered solutions.

The lock doesn't have a keyway due to the contactless NFC operation. It is designed to be used in harsh environments where the locks are exposed to dust, moisture and varying temperature conditions ranging from extremely cold to hot weather. The phone as a key enables flexible access sharing with time restrictions and audit trail reporting over the air. The security level is kept high and security gaps caused by lost key can be eliminated completely without costly change of locks and keys.

Feature summary

- battery-free programmable electromechanical padlock for iLOQ S50 locking system
- Available in three different shackle lengths (25mm/60mm/110mm)
- NFC-powered: no batteries required for the lock
- Opening with NFC enabled Android/iOS-smartphone or iLOQ K55S Key Fob
- Secured using powerful AES-256 encryption and mutual authentication
- Initial programming with PC and iLOQ P55S.1 Programming Token in connection to server
- Access right list for access groups
- Blocklist for individual lost keys
- Internal audit trail record with time stamp (can be configured on/off)
- Supports time restrictions
- Can be configured to require online opening authentication
- Re-programming with keys (Android/iOS phone or K55S Key Fob)
- Firmware updateable
- H50S.331: opening and closing with user credential
- H50S.341: opening with and closing without user credential
- Knob protected against impacts (e.g. fall)
- NFC 13,56 MHz Load modulation (ASK) ISO/IEC 14443A, no transmitter

Dimensional drawing

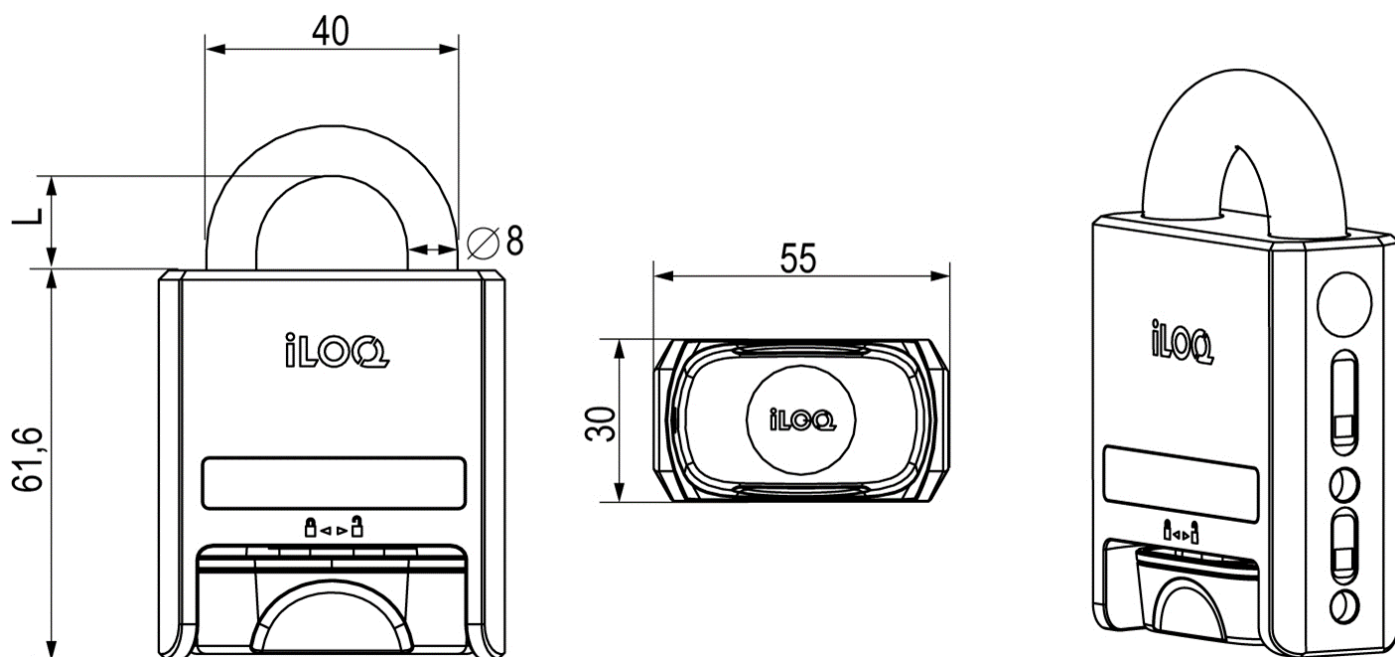

Memory capacity

Number of access rights	210
Number of blocklisted keys	500
Number of time slots	10
Size of event log	500

Technical data

Chain included	X
Corrosion resistance	96h salt spray
Ingress protection rating	IP68
Lockable without key	✓
Security grade	Grade 3
Reader type	Oval padlock reader
Surface treatment	Polished chrome
Maximum temperature	80°C
Minimum temperature	-40°C

Certificates

Attack resistance (EN 16864:2017)	Class 3
Category of use (EN 16864:2017)	Class 1
Corrosion resistance (EN 16864:2017)	Class 3
Durability (EN 16864:2017)	Class 1
Electronic key related security (EN 16864:2017)	Class D
Environmental resistance (EN 16864:2017)	Class 4
Mechanical key related security (EN 16864:2017)	Class 0
System management (EN 16864:2017)	Class 3
Other certificates	SSF 014, utgåva 3, class 2 LPS 1654 SR1