

## H50S.441.50.HC Padlock with 11/50mm shackle

---

### System-level description

The patented, award winning iLOQ S50 locking system offers advanced security and convenient access sharing capabilities for master-key locking environments.

The iLOQ H50S padlocks enable usage of the iLOQ S50 locking system for securing remote objects and locations. The lock harvests electricity wirelessly from NFC field, which enables using phone not only as a key but also as a power source thus the padlock is completely battery free. As no batteries are required, the padlocks are maintenance free and environmentally friendly green solution that eliminates work, costs, waste and harm associated with battery powered solutions.

The padlock doesn't have a keyway due to the contactless NFC operation. It is designed to be used in harsh environments where the padlocks are exposed to dust, moisture and varying temperature conditions ranging from extremely cold to hot weather.

The phone as a key enables flexible access sharing with time restrictions and audit trail reporting over the air. The security level is kept high and security gaps caused by lost key can be eliminated completely without costly change of locks and keys.

---

### Feature summary

- battery-free programmable electromechanical padlock for the iLOQ S50 locking system
- Available in two different shackle lengths (28mm/50mm)
- NFC-powered: no batteries required for the padlock
- Opening with NFC enabled smartphone (Android or iOS (13 and iPhone 7 and newer) or iLOQ K55S Key Fob)
- Secured using powerful AES-256 encryption and mutual authentication
- Initial programming with PC and iLOQ P55S.1 Programming Token in connection to the server
- Access right list for access groups
- Blocklist for individual lost keys
- Internal audit trail record with time stamp (can be configured on/off)
- Supports time restrictions
- Can be configured to require online opening authentication
- Re-programming with keys (NFC enabled smartphone or K55S Key Fob)
- Firmware updateable
- H50S.431: opening and closing with user credential
- H50S.441: opening with and closing without user credential
- Knob protected against impacts (e.g. fall)
- NFC 13,56 MHz Load modulation (ASK) ISO/IEC 14443A, no transmitter

## Dimensional drawing

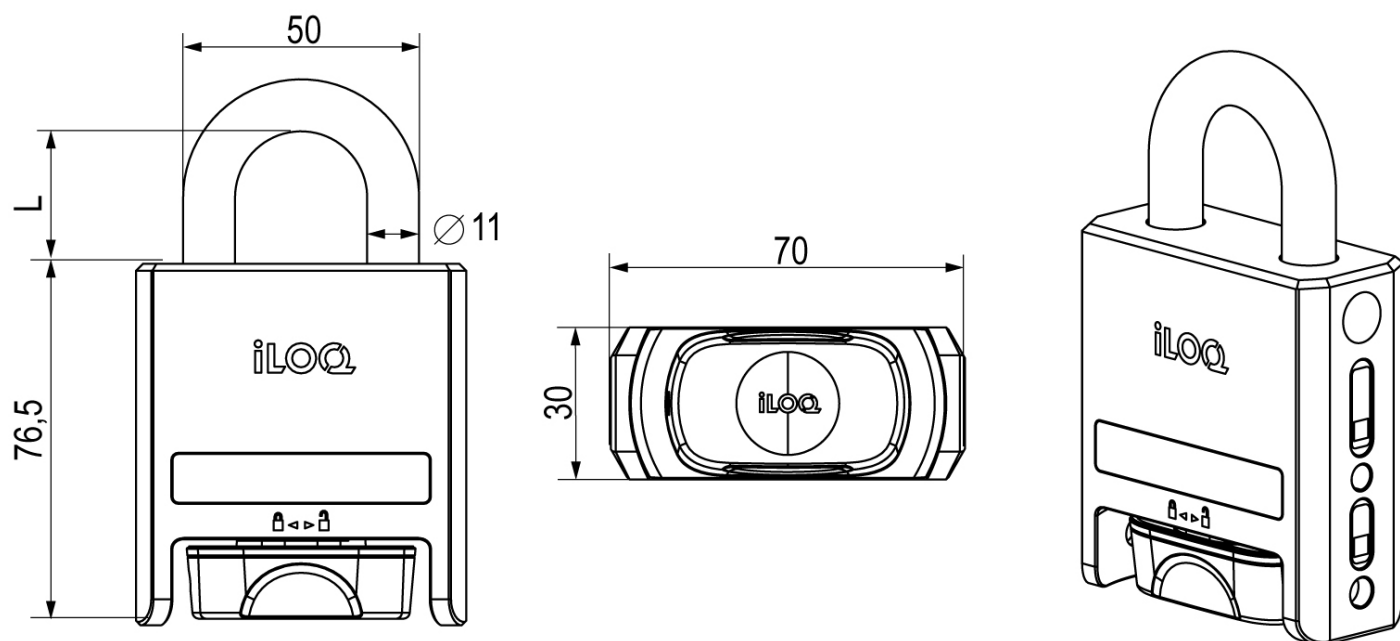

## Memory capacity

Number of access rights .....	210
Number of blocklisted keys .....	500
Number of time slots .....	10
Size of event log .....	500

## Technical data

Chain included .....	<b>X</b>
Corrosion resistance .....	96h salt spray
Ingress protection rating .....	IP67
Lockable without key .....	<b>✓</b>
Security grade .....	Grade 4
Reader type .....	Oval padlock reader
Surface treatment .....	Polished chrome
Maximum temperature .....	80°C
Minimum temperature .....	-40°C

## Certificates

Attack resistance (EN 16864:2017) .....	Class 4
Category of use (EN 16864:2017) .....	Class 1
Corrosion resistance (EN 16864:2017) .....	Class 3
Durability (EN 16864:2017) .....	Class 1
Electronic key related security (EN 16864:2017) .....	Class D
Environmental resistance (EN 16864:2017) .....	Class 4
Mechanical key related security (EN 16864:2017) .....	Class 0
System management (EN 16864:2017) .....	Class 3
Other certificates .....	LPS 1654 SR2